



 **Filtra**
Filtra Vibración S.L.



- 01. Presentation
- 02. Fairs
- 04. Granulometry
- 05. Sectors and application examples
- 06. Sieves
 - 08. Sieves and accessories
 - 09. Ultrasonic bath: **NEPTUNO**
 - 10. Mesh for laboratory sieves
 - 11. Testing laboratory accredited by ENAC
- 12. Filters
 - 14. Industrial mesh
- 15. Laboratory equipment
 - 16. Digital electromagnetic sieve shaker: **IRIS**
 - 20. Tapping sieve shaker: **SALOMÓN**
 - 21. Digital air jet sieve shaker: **EOLO**
 - 22. Laboratory grinding mill: **ARES**
 - 24. Laboratory V mixer: **VENUS**
- 25. Industrial equipment
 - 26. Circular sieve shaker: **ZEUS**
 - 28. Circular side engines sieve shaker: **HELIOS**
 - 29. Circular sieve shaker: **VULCANO**
 - 30. Mobile sieve shaker: **CENTAURO**
 - 31. Centrifugal sieve shaker: **MINERVA**
 - 32. Industrial V-Mixer: **ATENEA**
- 33. Accessories and spare parts

FILTRA reserves the right to change the dimensions and technical characteristics of this catalog without notice.



FILTRA VIBRACION, S.L. has been proud to celebrate its 25 years in the market developing and manufacturing laboratory and industrial process equipment for the sieving of solids and liquids and for the mixing and milling of solids. Another production line is the industrial filters made-to-measure according to customer specifications.

FILTRA offers high quality products at very competitive prices. All products strictly comply with national and international manufacturing standards, subjected to rigorous quality control and being delivered with an EC Declaration of compliance. The FILTRA quality management system for sieve manufacture is certified by TÜV NORD.

Following our policy of Quality and Innovation, FILTRA continues to investigate improvements and the development of new products.



Nº 44 100 131483

Manufacture of stainless steel mesh or perforated plate test sieves of diameter between 60 and 600 mm.



Laboratory accredited by ENAC for the emission of reports of wire mesh and perforated plate test sieves according to the following standards: UNE 7050-3, ISO 3310-1, ASTM E11, ISO 9044, UNE 7050-4, ISO 3310-2, ASTM E323.



FILTRA is a member of the Association of Scientific Equipment Manufacturers LABMAS SPAIN, which collaborates with other international industry associations.

Fairs



We distribute in more than 50 countries

We are leaders in the Spanish market, and currently sell in over 50 countries to multiple sectors -pharmacy, food, chemical industry, construction, recycling, agriculture, etc. - and applications.

Our hope is to continue growing and share our enthusiasm and satisfaction with our partners and customers.



Powtech Fair. Nuremberg



Expoquimia Fair. Barcelona



Achema Fair. Munich



Arablab Fair. Dubai



Exposólidos Fair. Barcelona

Granulometry

Granulometric classification or granulometry is defined as the measurement and grading which is performed on granules or particles of a solid material for analytical purposes, both on its origin and its mechanical properties, and the calculation of the proportion of the corresponding elements for each size on a granulometric scale.

What is the significance of granulometry?

Knowledge of the granule dimensions and the distribution according to size of the particles dispersed in solids is extremely important for research and development, production and quality control applications.

Based on the granulometric distribution, some of the product properties will vary, such as:

- Flavour
- Absorption
- Conductivity
- Miscibility
- Agglomeration due to cohesion/adhesion forces
- Mechanical properties
- Fracture properties
- Resistance to wear
- Surface reaction
- Insulation properties
- Filtration properties

Sectors and examples of application



The FILTRA sieves shakers can be used to classify and analyse a wide variety of products, both liquid and solid.

This equipment can be used in areas of research and development, quality control, and production process supervision.

The main sectors for application are:

- | | |
|--|--|
| <p>Food
Flours
Milk products
Tiger nut milk
Musts
Cereals
Spices
Pulses
Chocolate
Nuts
Meat products
Sugar
Coffee
Mineral salts
Fruit compots
Ice-creams
Juices</p> <p>Agriculture
Fertilizers
Seed
Grain
Herbs
Flowers</p> <p>Chemical and Petrochemical
Glues/adhesives
Paints
Toner
Plastic and polyamides, etc
Masterbach
Pet
PVC
Lubricants
Resins</p> <p>Recycling
Paper pulp
Waste water
Glass
Slurry
Waste oils
Plastics
Copper
Wood</p> | <p>Construction
Filling materials
Sand
Clay
Cement and derivatives
Plaster</p> <p>Cosmetics and hygiene
Detergents
Soaps
Pigments
Surfactants</p> <p>Ceramics
Stains
Enamels
Pigments
Clay</p> <p>Mining
Metals
Metal oxides
Kaolin
Explosives
Minerals
Diamonds</p> <p>Pharmaceuticals
Medicines and drugs</p> |
|--|--|



Sieves

FILTRA VIBRACION, S.L manufactures a wide range of laboratory sieves with diameters from 60 to 600 mm, with top quality AISI 304 or AISI 316 stainless steel for the frame, AISI 304 for the perforated plates, and AISI 316 for the metal meshes, providing excellent durability and high resistance to corrosion.



They are all manufactured in strict compliance with UNE, ISO, ASTM, AFNOR, BS, etc. national and international regulations. The FILTRA Quality Management System for the manufacture of these sieves is certified by TÜV NORD, in accordance with UNE-EN ISO 9001:2000 regulations.

They are manufactured in two pieces, allowing the mesh to be changed when it has deteriorated or does not meet the regulations. The interior sieve surface is totally flat to prevent the accumulation of residue and dirt. Cleaning is very fast and easy.



Nº 44 100 131483

Manufacture of stainless steel mesh or perforated plate test sieves of diameter between 60 and 600 mm.

Our laboratory sieves have a rubber seal included in order to ensure they fit tightly. In addition, they can be fitted together and fitted to those from other manufacturers perfectly.

Marking is done by laser etching on the frame, giving each sieve an individual identification number, which allows for subsequent tracing.



QUALITY

Before being supplied, each sieve is subjected to optical calibration and provided with a manufacturer's certificate and documentation regarding maintenance.

We also have lids and bottoms in stainless steel in all diameters for which we manufacture the sieves.



Table of the various diameters and heights of FILTRA sieves



D	Hu	Ht	P	V
60	25	30	60	5
60	75	85	120	15
75	25	40	85	25
100	20	35	100	50
100	50	60	150	75
125	20	34	165	85
150	30	43	200	100
150	50	60	250	120
200	25	50	450	70
200	50	70	500	140
200	100	120	800	250
200	200	220	1000	500
203	25	50	450	70
203	50	70	500	140
250	70	90	900	280
300	80	95	1250	560
305	50	70	1250	560
315	80	95	1300	560
350	80	100	1500	600
400	65	85	1700	600
400	100	115	2000	650
450	100	115	2200	750
500	100	115	3000	850
600	110	125	3600	1000

D	DIAMETER (mm)
Hu	USEFUL HEIGHT (mm)
Ht	TOTAL HEIGHT (mm)
P	THEORETICAL WEIGHT (g) (Depending on Mesh)
V	RECOMMENDED VOLUME (with mesh of 1 mm cm ³)

ADVANTAGES:

- Manufacture according to national and international regulations.
- High quality. High resistance to corrosion. Excellent durability.
- Manufactured in two pieces: allows the mesh to be changed.
- Totally flat surface for easy cleaning. Product residues do not accumulate.
- Individual identification by laser, allows the sieve to be traced.
- The sieves can be fitted together and fitted to those from other manufacturers perfectly.
- Maximum stability and sealed fit for sieves stacks.

Sieves and Accessories

FILTRA offers a wide range of sieves in a variety of sizes, shapes and materials, together with complementary equipment.



Sieve with stainless steel frame and mesh.



Stainless steel sieve with square-holed perforated plate.



Stainless steel framed sieve with nylon mesh.



Stainless steel sieve with oval-holed perforated plate (for cereals, ISO 5223).



Stainless steel sieve with round-holed perforated plate.



Special stainless steel sieve for EOLO-FTLBA (Air Jet) sieve shaker, with stainless steel or nylon mesh.



Special test sieves: conical, double height, half height, etc.



Grid Sieves made of paint carbon steel.



Stainless steel lids and receivers in all sizes.



Sieve shelves.



Cleaning brushes for sieves.



Food balls used to open the mesh of sieve.

Ultrasonic Bath

NEPTUNO

A NEPTUNO ultrasonic bath is the perfect accessory to maintain and clean laboratory sieves and other pieces of equipment.

Ultrasonic cleaning is currently the most modern and effective cleaning system: the alternate high and low pressure waves produce a frequency which, through the cavitation phenomenon, leads to the production of millions of microscopic bubbles which impact on the object surface, loosening dirt in minimum time.

Ultrasonic baths have low electrical energy consumption and save time when compared to brushing out or other traditional methods. The areas which are difficult to access become clean and without traces of dirt, while the object surface is not damaged, as can happen with other methods.

The NEPTUNO ultrasonic baths are made from stainless steel (AISI 304). We have various models according to capacity: 0.7 / 1 / 1.5 / 3 / 6 / 10 / 14 / 28 / 35 / 50 L.



GENERAL EQUIPMENT CHARACTERISTICS:

- **Power-supply voltage:**
200 – 240 V ac ± 10 %
50 – 60 Hz.
- **Current and power surge protection.**
- **Digital control panel.** It allows monitoring of the receptacle temperature, modification of the operating temperature, ultrasonic action time and the switching on and activation of the cleaning equipment.
- **High performance steel-aluminium piezoelectric transducers** (the number of transducers will depend on the power of the equipment).
- **Working temperature range:** from 0 to 80 °C.

	Frequency Ultrasound (KHz)	Power Ultrasound (W)	Power Heating (W)	Dimensions Internal (mm) W x L x H	Weight (Kg)	Drainage
COMBAÑO 0,7L	40	50	100	85 x 150 x 60	1,8	NO
COMBAÑO 1L	40	50	100	120 x 130 x 65	2,1	½"
COMBAÑO 1,5L	40	50	100	130 x 140 x 100	2,3	½"
COMBAÑO 3L	40	100	100	130 x 230 x 100	3,7	½"
COMBAÑO 6L	40	200	150	150 x 300 x 150	5,7	½"
COMBAÑO 10L	40	300	200	235 x 295 x 150	9	½"
COMBAÑO 14L	40	500	300	295 x 325 x 150	14	½"
COMBAÑO 28L	40	600	750	295 x 495 x 200	18	½"
COMBAÑO 35L	40	700	1000	295 x 395 x 300	25	½"
COMBAÑO 50L	40	800	1000	300 x 600 x 300	40	½"

Mesh / Perforated Plate for Laboratory Sieves

ENAC (Spanish National Accreditation Agency) Test Laboratory

Table of normalized openings in metal mesh and plate for the manufacture of laboratory sieves, according to various international Regulations

METALLIC MESH

mm (millimeters)

UNE 7050-3 ISO 3310-1	ASTM E11	
W*	W*	Nº
125	125	5 in.
112		
106	106	4,24 in.
100	100	4 in.
90	90	3 1/2 in.
80		
75	75	3 in.
71		
63	63	2 1/2 in.
56		
53	53	2,12 in.
50	50	2 in.
45	45	1 3/4 in.
40		
37,5	37,5	1 1/2 in.
35,5		
31,5	31,5	1 1/4 in.
28		
26,5	26,5	1,06 in.
25	25	1 in.
22,4	22,4	7/8 in.
20		
19	19	3/4 in.
18		
16	16	5/8 in.
14		
13,2	13,2	0,530 in.
12,5	12,5	1/2 in.
11,2	11,2	7/16 in.
10		
9,5	9,5	3/8 in.
9		
8	8	5/16 in.
7,1		
6,7	6,7	0,265 in.
6,3	6,3	1/4 in.
5,6	5,6	3/12
5		
4,75	4,75	4
4,5		
4	4	5
3,55		
3,35	3,35	6
3,15		
2,8	2,8	7
2,5		
2,36	2,36	8
2,24		
2	2	10
1,8		
1,7	1,7	12
1,6		
1,4	1,4	14
1,25		
1,18	1,18	16
1,12		
1	1	18

µm (micrometers)

UNE 7050-3 ISO 3310-1	ASTM E11	
W*	W*	Nº
900		
850	850	20
800		
710	710	25
630		
600	600	30
560		
500	500	35
450		
425	425	40
400		
355	355	45
315		
300	300	50
280		
250	250	60
224		
212	212	70
200		
180	180	80
160		
150	150	100
140		
125	125	120
112		
106	106	140
100		
90	90	170
80		
75	75	200
71		
63	63	230
56		
53	53	270
50		
45	45	325
40		
38	38	400
36		
32	32	450
25	25	500
20	20	635

PERFORATED PLATE

mm (millimeters)

UNE 7050-4 ISO 3310-2	ASTM E323	
W*	W*	Nº
● ■ 125	● ■ 125	5 in.
● ■ 112		
● ■ 106	● ■ 106	4 1/4 in.
● ■ 100	● ■ 100	4 in.
● ■ 90	● ■ 90	3 1/2 in.
● ■ 80		
● ■ 75	● ■ 75	3 in.
● ■ 71		
● ■ 63	● ■ 63	2 1/2 in.
● ■ 56		
● ■ 53	● ■ 53	2 1/8 in.
● ■ 50	● ■ 50	2 in.
● ■ 45	● ■ 45	1 3/4 in.
● ■ 40		
● ■ 37,5	● ■ 37,5	1 1/2 in.
● ■ 35,5		
● ■ 31,5	● ■ 31,5	1 1/4 in.
● ■ 28		
● ■ 26,5	● ■ 26,5	11/16 in.
● ■ 25	● ■ 25	1 in.
● ■ 22,4	● ■ 22,4	7/8 in.
● ■ 20		
● ■ 19	● ■ 19	3/4 in.
● ■ 18		
● ■ 16	● ■ 16	5/8 in.
● ■ 14		
● ■ 13,2	● ■ 13,2	17/32 in.
● ■ 12,5	● ■ 12,5	1/2 in.
● ■ 11,2	● ■ 11,2	7/16 in.
● ■ 10		
● ■ 9,5	● ■ 9,5	3/8 in.
● ■ 9		
● ■ 8	● ■ 8	5/16 in.
● ■ 7,1		
● ■ 6,7	● ■ 6,7	17/64 in.
● ■ 6,3	● ■ 6,3	1/4 in.
● ■ 5,6	● ■ 5,6	7/32 in.
● ■ 5		
● ■ 4,75	● ■ 4,75	3/16 in.
● ■ 4,5		
● ■ 4	● ■ 4	5/32 in.
● 3,55		
● 3,35	● 3,35	1/8 in.
● 3,15		
● 2,8	● 2,8	7/64 in.
● 2,5		
● 2,36	● 2,36	3/62 in.
● 2,24		
● 2	● 2	0,078 in.
● 1,8		
● 1,7	● 1,7	0,066 in.
● 1,6		
● 1,4	● 1,4	0,055 in.
● 1,25		
● 1,18	● 1,18	0,045 in.
● 1,12		
● 1	● 1	0,039 in.

In 2002 FILTRA VIBRACION, S.L set up the first ENAC accredited laboratory in Spain (Accreditation no. 310/LE683) for the carrying out of Trials for metal mesh and plates in accordance with the following regulations:

Mesh	Plates
UNE 7050-3	UNE 7050-4
ISO 3310-1	ISO 3310-2
ASTM E11	ASTM E323
ISO 9044	

The laboratory technical personnel, using artificial vision equipment and following methods established by the UNE-EN ISO/IEC 17025:2005 regulation governing our quality systems, carry out necessary measurements and calculations in order to issue a trial report which, together with other results, determines whether the mesh or perforated plate of the examined sieve conforms to the reference regulation.

ENAC accreditation is recognized internationally through MLA (Multilateral Agreement) or MRA (Mutual Recognition Agreement).



*W = Mesh light (opening size)

Filters

METALLIC MESH FILTERS

At FILTRA VIBRACIÓN, S.L. we specialize in the manufacture of all types of metal mesh industrial filters. We have a team with over 20 years' experience in this field, developing, together with our customers, solutions in filter consumables for multiple industrial sectors such as chemicals, petrochemicals, pharmaceutical, plastics, resins, thermal oils, etc.

We manufacture a multitude of industrial filters in AISI 304 or AISI 306 stainless steel: cylindrical filters, DN22 to DN 600Y-type; DN25 to DN600 filter baskets, pleated filters with one or various mesh layers; conical and truncated conical filters; interchangeable plugs; mesh disks; special elements.

We develop and manufacture made-to-measure products according to the client's plans or specifications, from a single unit to whole ranges.

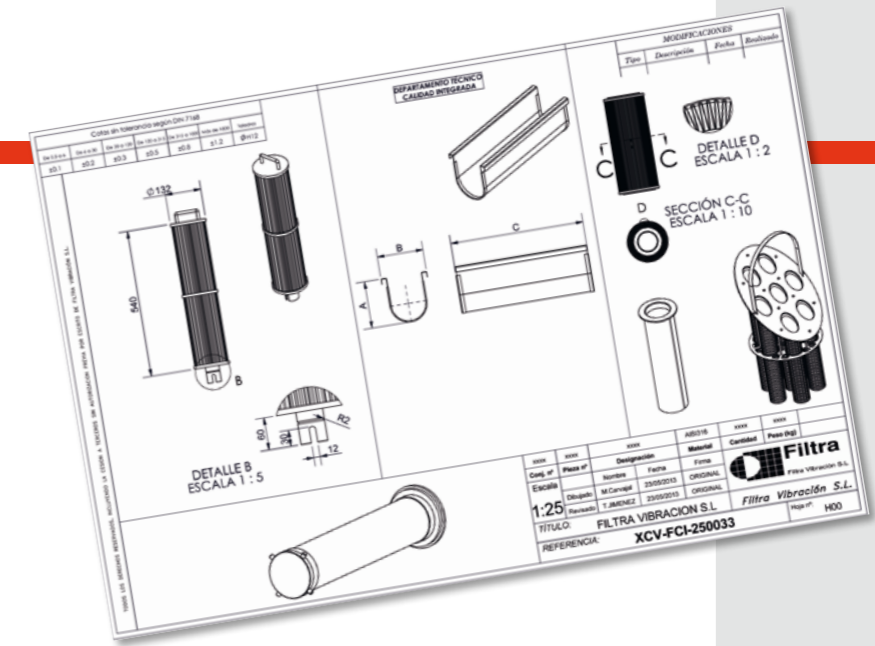
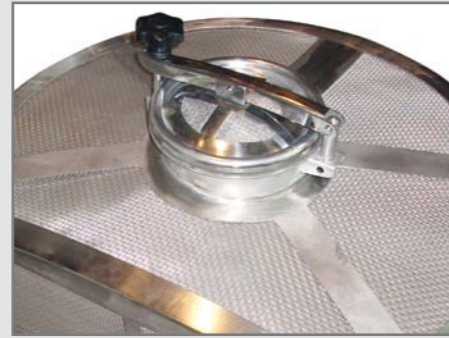

METALLIC MESH Sieves

We manufacture all types of custom metal sieves with a single mesh or multiple or with reinforcement structure where necessary.



NON-METALLIC FILTERS

We supply synthetic filters made of polypropylene, polyester or polyamide: sleeves and bag filters, mini weaves, filter discs, cartridges, mesh fabrics for fluidization and nylon mesh bulk meters.



Industrial Mesh

METALLIC MESH

We have a large stock of stainless steel mesh AISI 304 and 316 acc/ISO 9044 to supply in rolls, panels or bulk meters: plain fabric, twill, wave, electro, sintered or Repts.

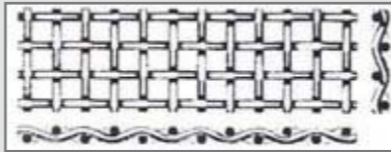

Table of standardized opening mesh sizes for production of industry sieves.

Lightweight Group		
Opening size (mm)	Ø Wire (mm)	% Useful surface
1,440	0,300	68,80
1,126	0,280	66,50
1,150	0,240	68,50
1,030	0,230	66,50
0,880	0,230	62,40
0,726	0,200	62,00
0,594	0,200	55,20
0,534	0,160	58,20
0,457	0,160	55,50
0,416	0,140	57,10
0,385	0,120	56,50
0,343	0,120	53,80
0,307	0,120	52,50
0,277	0,120	49,70
0,270	0,100	53,10
0,247	0,100	51,80
0,219	0,090	50,60
0,198	0,080	51,80
0,188	0,090	45,60
0,173	0,080	46,30
0,161	0,070	48,30
0,150	0,063	49,30
0,128	0,070	49,30
0,125	0,060	45,50
0,124	0,050	50,10
0,104	0,050	45,20
0,089	0,050	40,90
0,080	0,050	46,30
0,075	0,036	36,20
0,063	0,063	34,80
0,056	0,036	35,30
0,049	0,030	34,80
0,042	0,036	28,00
0,040	0,030	33,20
0,025	0,025	24,90

Strong Group		
Opening size (mm)	Ø Wire (mm)	% Useful surface
19,716	2,5	78,80
11,880	2	73,40
9,5	1,6	73,40
7,96	1,3	73,70
5,84	1,1	70,30
4,56	1	67,00
4	1	64,30
3,73	0,9	64,80
3,17	0,8	63,60
2,77	0,7	63,50
2,39	0,7	59,40
2,18	0,6	61,40
1,81	0,5	60,90
1,48	0,5	55,50
1,3	0,44	54,30
1,12	0,42	52,10
0,99	0,40	50,60
0,75	0,36	45,50
0,606	0,32	43,20
0,514	0,28	41,20
0,454	0,24	41,90
0,36	0,20	41,30
0,283	0,18	36,40
0,237	0,16	36,40
0,207	0,14	36,40
0,189	0,12	37,00
0,168	0,11	36,40
0,153	0,10	36,10
0,141	0,09	37,00
0,125	0,08	35,20
0,111	0,063	40,00
0,104	0,050	45,63
0,088	0,050	40,75
0,076	0,045	36,55
0,061	0,045	30,25
0,057	0,035	38,30
0,049	0,030	31,00
0,039	0,030	33,70
0,032	0,025	31,00
0,025	0,025	25,00
0,020	0,020	25,00

Superstrong Group		
Opening size (mm)	Ø Wire (mm)	% Useful surface
25	3	79,50
19,72	2,5	78,80
16,51	2	79,40
10	2,2	67,00
8	2	73,00
6,3	1,6	64,00
5	2	51,00
5	1,2	65,00
4	1	64,00
3	1	56,00
2,5	1	51,00
2	1	44,00
1,6	0,70	48,00
1,5	1	36,00
1,23	0,5	51,00
1,18	0,55	47,00
1,08	0,65	39,00
0,9	0,36	51,00
0,82	0,44	42,00
0,71	0,40	41,00
0,52	0,40	32,00
0,40	0,22	42,00
0,30	0,20	36,00



Plain fabric square

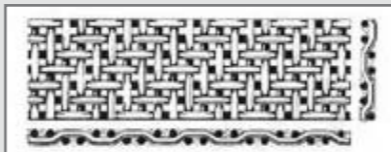

Plain fabric twill

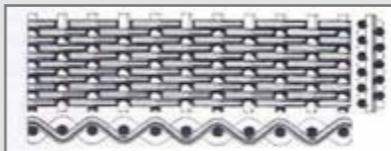

Fabric Repts together

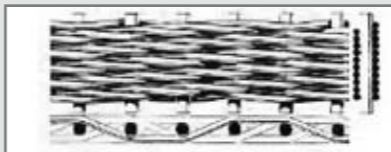

Fabric Repts twill together



Laboratory Equipment



Electromagnetic Sieve Shaker

The FILTRA electromagnetic sieve shakers are used in research and development, and in quality control for production processes, both for raw materials and intermediate and finished products. With them it is possible to carry out granulometric testing for particle separation, both for dry and wet conditions.

The IRIS model sieve shakers are highly effective, thanks to the three-dimensional particle motion, created by an electromagnet. With this 3D effect the particles bounce over the whole sieve area, forcing them to pass through to the lower sieve more quickly. Thus a faster, more effective sieving is achieved through the whole sieve column.

There are four models: FTS-200, FTL-200, FTL-300 and FTL-400, which cover sieves from 60 mm Ø to 400 mm Ø for samples from 25 gr to 25 kg of product. The particle size to be analysed can range from 25µ to 125 mm. Each user can choose the equipment which is best suited to their needs.



All models include digital power control (from 1 to 9), sieving time (from 0 to 99 min.) and the sieving mode; continuous or intermittent.

All the sieve shakers are equipped with an anti-vibration system which, together with the anchoring system, ensures complete stability during the sieving.

Depending on the model, it is possible to choose between the standard fixation system, and the "Easy-Press" rapid fixation system. The methacrylate lid makes observing the product during the sieving process easy.

All equipment is subjected to strict quality control, which guarantees years and years of problem-free use.

IRIS

Examples of application:

Foodstuffs, earth, coal, construction materials, chemical and pharmaceutical products.



IRIS FTL-0200

Digital electromatic sieve shaker for sieves from Ø 60 a 203 mm. Its three-dimensional movement throughout the sieve column makes it very effective when carrying out granulometric test. It includes digital power, timing and intermittence controls for sieving. It can be supplied with the standard anchoring system or with the "Easy-Press" rapid system. It permits 8 sieves of 50 mm in height, or 16 sieves of 25 mm in height.

ANCHORING SYSTEMS:

• **Standard:** Threaded rods, bakelite knobs and methacrylate lid.



• **"Easy-Press":** smooth rods, pressurized tightening knobs which easily slide along the rods, and a methacrylate lid.



IRIS FTS-0200

Small, compact and light, it is the economic option from the IRIS range of electromagnetic sieves. Allows sieves from Ø 60 to 203 mm Up to 7 sieves of 50 mm in height, or 14 sieves of 25 mm in height. It includes digital power, timing and intermittence controls for sieving. It is supplied with the standard fixation system.



ADVANTAGES:

- Three-dimensional motion.
- Highly effective: short sieving times
- Sieving for dry and wet test
- Ergonomic design
- Digital adjustment of sieving parameters
- Easy to operate
- Integrated interface
- Anti-vibration system
- Silent
- Maintenance free



Examples of application:

Minerals, fertilizers, plastics, metals, seeds, flowers, herbs, grain, wood-chip, fibres, etc.



IRIS FTL-0300

Designed for high sample volumes, it can admit 5 sieves of 80 mm in height, or 8 sieves of 50 mm in height. The diameters range from 250 to 305 mm. The power, time of sieving and intermittence are all digitally adjusted.

It can be supplied with the standard fixation system or with the "Easy-Press" rapid system, according to your choice.

ACCESSORIES:

- Methacrylate lid for dry test.
- Methacrylate lid with stainless steel diffusing ball for wet test.



- Stainless steel receiver for dry test.
- Stainless steel receiver with outlet for wet test (including hose and flange).
- Stainless steel lid.
- "Easy-Press" rapid anchoring system (smooth rods and pressurized tightening knobs).

IRIS FTL-0400

It allows a large load capacity. It is designed for sieves from Ø 400 mm, although it can also allow smaller diameters. With the highly effective 3D motion, sieving times are short; even with large product samples. Like the other models, it includes digital power, timing and intermittence controls for sieving.

It is possible to choose between the standard anchoring system and the "Easy-Press" rapid system.



- Feed balls to ease the passage of the product in the sieve.
- Cleaning brushes.
- Freeing tool.



	IRIS			
	FTS-0200	FTL-0200	FTL-0300	FTL-0400
Sieve Shaker Type	Electromagnetic	Electromagnetic	Electromagnetic	Electromagnetic
Dry test	Yes	Yes	Yes	Yes
Wet test	Yes	Yes	Yes	Yes
Levels of Power	9	9	9	9
Size of Particle	20 µ a 125 mm	20 µ a 125 mm	20 µ a 125 mm	20 µ a 125 mm
Number of Sieves (mm)	7 x Ø200x50 14 x Ø200x25	8 x Ø200x50 16 x Ø200x25	5 x Ø300x80 8 x Ø300x50	4 x Ø400x100
Max. Diameter of Sieve (mm)	203	203	315	400
Timer (min)	1 a 99	1 a 99	1 a 99	1 a 99
Tension	220/240 V - 50/60 Hz.	220/240 V - 50/60 Hz.	220/240 V - 50/60 Hz.	220/240 V - 50/60 Hz.
Intensity (A)	0,8	0,8	0,8	0,8
Power (kW)	0,4	0,4	0,4	0,4
Weight (Kg)	27	40	45	48
Dimensions L x W x H (mm)	305 x 630	254 x 800	254 x 800	555 x 630 x 750

Tapping Sieve Shaker

FT-VG-200

The Sieve Shaker Salomon performs the sieving process reproducing the movements of the hand sieving, the combination of oscillating movements and tapping on the top part facilitates the passage of the particles of the sample, avoiding the clogging of sieves.

The equipment is fully provided with acoustic insulation to minimize the degree of noise during sieving.



Includes:

- Sound Enclosure Cabinet provided with acoustic insulation and protection sensor to stop the machine when the door is open for Safety.
- Metal support for sieves with adjustable height.
- Top metal lid with rubber stopper.
- Tapping arm situated in the upper part of equipment, driven by an axis which acts jointly with the oscillating movement of sieving and allows the beating at the top of the sieves.
- Driving set composed of a motor of 1.5 kW at 220 V monophasic and the corresponding pulleys toothed belt transmission.

TECHNICAL CHARACTERISTICS	
Number of Sieves (mm)	6 x Ø 200 x 50
Rotation speed (r.p.m.)	275
Tapping speed (taps/min)	144
Dimensions L x W x H (mm)	810 x 540 x 750
Electrical connection (V)	220 Monophasic
Power (W)	750
Weight (Kg)	178

SALOMON

Examples of application:

Sands, chemicals and pharmaceuticals products, seeds, shavings, plastics, wood, etc.



DRIVING DIGITAL MODULE INCLUDING:

- Switch on / off process.
- Switch "mushroom" emergency stop.
- Digital programmer sieving time.

Digital Air Jet Sieve Shaker

FTLBA

The EOLO digital air jet sieve shaker has been specially designed for dry granulometric testing, for fine particles from 5 microns in size (from 0.005 to 4 mm).

It offers fast, effective sieving thanks to the flow of the product obtained forced by a current of air which forces the particles through the sieve. This effect is obtained using an industrial vacuum which maintains constant depression.

It features a digital panel with sieving time regulation (1 to 99 minutes) and Vacuum Meter, which incorporates a depression regulator valve in order to select the necessary depression for each test.

The sieve shaker includes a methacrylate lid which allows the product behaviour to be observed, and a nylon mallet to loosen the residual product which is stuck to the lid due to the effects of static electricity.

The use of FILTRA quality Air Jet sieves of Ø200 mm (not included) is recommended.



TECHNICAL CHARACTERISTICS	
Sieve Shaker Type	Air jet
Dry test	YES
Wet test	NO
Size of Particle	5 µm a 4 mm
Number of Sieves	1
Diameter of Sieve (mm)	200
Timer (min)	1 a 99
Tension	220/240 V - 50/60 Hz.
Power (kW)	0,19
Máximum Depression (Kpa)	20
Weight (Kg)	20
Dimensions ØxH (mm)	360 x 275

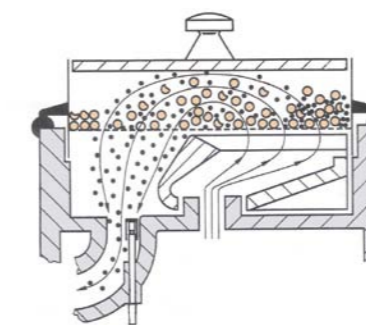

Current of air which forces the particles through the sieve.

EOLO

Examples of application:

Food powders, fine sand, construction materials, chemical and pharmaceutical products, minerals, fertilizers, powdered plastics, powdered metals, fibres, etc.



ACCESSORIES:

- Methacrylate lid.
- Nylon mallet.
- NILFISK GM-80 vacuum.
- FILTRA Ø 200 mm Air Jet sieves.
- Cleaning brushes.
- Freeing tool.
- Ultrasound bath for sieves cleaning.



ADVANTAGES:

- Highly effective in the sieving of fine particles: very short sieving times.
- Dry sieving.
- Ergonomic design.
- Digital adjustment of sieving parameters.
- Easy to operate.
- Integrated interface.
- Silent
- Maintenance free

Laboratory Grinding Mill

ARES

ARES

FML-0100 / FML-2000

FILTRA manufacture two different models of laboratory Grinding Hammer Mills, in order to cover the different customer needs: ARES FML-0100 is a small and economical one for milling small quantities of product and ARES FML-2000 with the double of capacity for biggest quantities of product or biggest articles.

They are used to grind a wide variety of soft, semi-hard and hard materials, such as cereals, spices, vegetables, plastics, resins, minerals, earth, stone, coal, etc. with a particle feed size of +/- 15 mm in FML-0100 and of +/- 20mm in FML-2000.

The feeding is supplied by a hopper located at the top and can be dosed manually using a chopper. The door has a quick locking with a safety micro-sensor which stops the rotation of the hammers when it's opened.

Both the front and loading hopper are manufactured from mirror-polished AISI 304 stainless steel. In the interior the 3 hammers are made from anti-wear AISI 410 stainless steel. The equipment includes an easily interchangeable sieve with round perforations.

In ARES FML-2000 model, plus the sieve, the blades and the toothed crown are also interchangeable, and can be easily removed for cleaning without using any key. This model incorporates a potentiometer to regulate the engine speed.

Examples of application:

Grain food, cereals, seeds, spices, vegetables, stones, earth, minerals, resins, plastics, chemical products, construction materials, ceramics, pharmaceutical products, etc.



ARES FML-0100

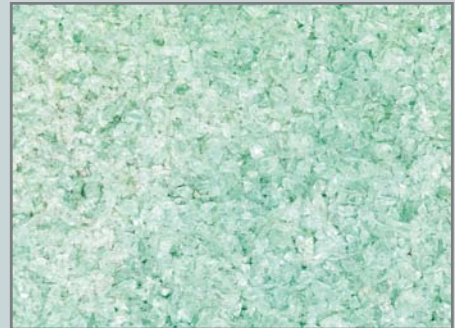

ARES FML-2000



ADVANTAGES:

- Easy cleaning thanks to the interchangeable toothed crown and sieves without the need of tools.
- Potentiometer to regulate motor velocity.
- Removable polished stainless steel loading hopper and collecting drawer, for ease of cleaning.
- Very fine end granulometry.

MODEL	Timer (min)	Tension	Power (Kw)	Speed (rpm)	Grinding chamber Dimensions (mm)	Loading hopper Volume (l)	Grinding chamber Volume (l)	Drawer Volume (l)	Weight (kg)	Number of hammers	Size of sieve holes (Ø mm)	Máximum Hardness (Mohs)	Maximum size of particle at the entrance (mm)	General dimensions (mm)
FML-0100	0 - 99	220-240 V (50-60 Hz)	1,9	3000	Ø110x66	1,2	0,4	1	38	3	1,2,3,4,5	6-7	15	225 x600 x420
FML-2000	0 - 99	220-240 V (50-60 Hz)	2,6	3000	Ø150x88	5,5	1,2	2	72	3	0,5, 0,8, 1, 1,5, 2, 2,5, 3,4,5,6	6-7	20	520 x700 x700

Laboratory V-Mixer

VENUS

FTLMV-0,5 / 01 / 02 / 04 / 08

The VENUS V-shaped laboratory mixers are used in the precision homogenization of powdered or granulated products in the pharmaceutical, chemical and food industries. It can gently and evenly mix solids with solids, in any percentage, or solids with liquids (maximum 10%).

It has two loading inlets with silicon lids and one outlet with a dosing valve. The product introduced revolves through 360° via mechanical transmission. Its characteristic V-shape means axial currents are produced when the body is turned, and these separate and unite the material. This, along with the radial mixing action, produces an extremely homogeneous result (in the proportion of 1 part in 10.000) without the need for paddles or other devices.

The mix containers are manufactured from AISI-316 stainless steel with a polished mirror finish inside and outside. Its angle and corner-free design prevents the accumulation of product residue in the interior.

The mixer works with a single-phase motor and has a timer, stop/start switch and fuse box.

The useful capacity, in order to achieve the correct homogenization, is 50% of the total mixer volume. The FILTRA V mixers are available in 0'5, 1, 2, 4 and 8 litres (total capacity).

Examples of application:

Food powder, chemicals and pharmaceuticals, metals, plastics, additives, etc.



ADVANTAGES:

- Precision mixing. Maximum product homogenization.
- High quality materials and finishes.
- Free of interior angles or corners; there is no build up of product residue.
- Silent.
- Maintenance free



MODEL	Timer		Tension	Mixer Power (Kw)	Weight (kg)	Useful Volume (l)	Nº de vueltas deposito x min. (rpm)	Dimensions L x W x H (mm)
FTLMV-0,5	Mechanical	60 min.	220-240 V 50-60 Hz	0,1	15	0,25	38	415 x 400 x 415
FTLMV-01	Mechanical	60 min.	220-240 V 50-60 Hz	0,1	17	0,5	38	415 x 400 x 415
FTLMV-02	Mechanical	60 min.	220-240 V 50-60 Hz	0,1	17	1	38	415 x 400 x 430
FTLMV-04	Mechanical	60 min.	220-240 V 50-60 Hz	0,1	20	2	25	550 x 400 x 550
FTLMV-08	Mechanical	60 min.	220-240 V 50-60 Hz	0,25	25	4	18	700 x 450 x 650



Industrial Equipment



Circular Sieve Shaker

ZEUS

ZEUS

FTI-0550 / 0800 / 1200 / 1500

The ZEUS sieve shaker is suitable for large production volumes in industrial sieving. It can be used for separation processes for solids in a liquid, for the separation of different granulometries within the same product, in safety sieving for the elimination of foreign bodies, for the homogenization of particles, etc.

It permits a production volume of 100 to 25,000 kg/h, depending on the product, the mesh opening size and the feed flow to the machine. It is suitable for sieving from 36 microns to 25 mm.

Manufactured from AISI 304 stainless steel (or AISI 316 on request), it features an imbalanced-weight motor which produces a three-dimensional motion which makes the sieving of the product very effective. Adjustment of the imbalanced-weights allows the regulation of product behaviour on the mesh and the sieving speed.

The bottom has a side outlet through which the obtained product can be unloaded. The sieves can be ordered with or without product outlet. In the case of choosing a sieve with outlet, the sieving process can be automated: as the product enters the sieve shaker, it also leaves via the sieve opening.

The ZEUS model allows up to 4 sieves, with which up to 5 product separations are obtained. The possible diameters are: 550, 800, 1200 or 1500 mm. As an option it can be ordered with fast-closing clamps, lid, viewing windows in the lid and body, and wheels. If the sieve shaker is going to be used in areas classified as being potentially explosive environments then it is manufactured with ATEX materials, and FILTRA will supply the corresponding ATEX certificate. No special floor or foundation is necessary for its installation.

Examples of application:

Chemical, pharmaceutical, agricultural, fishery, forestry, biological and food products, paints, sand, metals, wood, plastic, glass, recycling, waste water treatment, etc.



ADVANTAGES:

- Sieve for large production volume.
- Highly robust. It can work for 24 hours.
- Highly versatile. Easy to operate.
- Sieves with or without product outlet (to choose).
- Can have wheels fitted
- Low maintenance.

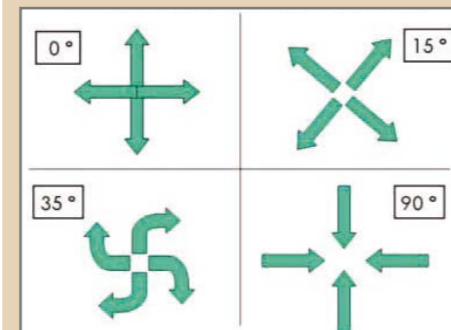

Product adjustable movement over the mesh.

MODEL	Sieve Shaker Type	Max. Number of sieves	Sieve Diameter	Tension (V)		Intensity (A)		Power (Kw)		Speed (rpm)		Weight * (Kg)	Dimensions *ØxH mm
				50 Hz	60 Hz	50 Hz	60 Hz	50 Hz	60 Hz	50 Hz	60 Hz		
FTI-0550	Circular	4	550	400	460	1	1,02	0,42	0,5	1500	1800	95	710 * 755
FTI-0800	Circular	4	800	400	460	2,2	2	1,20	1,25	1500	1800	150	710 x 755
FTI-1200	Circular	4	1200	400	460	3	3,1	1,80	2	1500	1800	320	710 x 755
FTI-1500	Circular	4	1500	400	460	3	3,1	1,80	2	1500	1800	370	710 x 755

* Size and weight for standard configuration: 1 level + lid

Side Motors Circular Sieve Shaker

FTI-2M-0550 / 0800 / 1200

The HELIOS sieve shaker is especially recommended for control and safety sieving for both solids and liquids. It is very useful in confined spaces where the reception of material and the unloading of the sieved product are in close proximity. It permits a large product volume and a single sieving level.

They are often installed at the outlet of discharge chutes, grinding mills, mixers, etc. The inlet feed and product outlets are on the centre of the sieve shaker itself, it acting practically as a strainer. It is easy to install. It can be supplied on a wheeled support or alone, to be inserted within an installation.

It is made from stainless steel (AISI 304 or AISI 316) with two lateral motors, fitted on opposite sides, through which a three-dimensional motion in the horizontal and vertical planes is achieved, allowing excellent material flow.



If the sieve shaker is going to be used in areas classified as being potentially explosive environments then it is manufactured with ATEX materials, and FILTRA will supply the corresponding ATEX certificate.

It is available in three diameters: 550, 800 and 1200 mm.

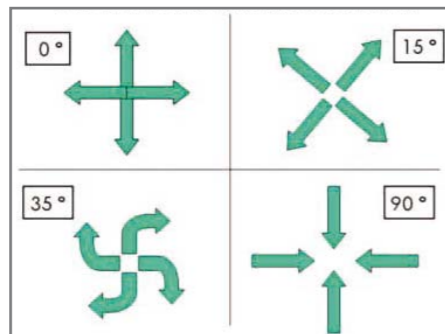

Product adjustable movement over the mesh.

MODEL	Sieve Shaker Type	Max. Number of sieves	Sieve Diameter	Tension (V)		Intensity (A)		Power (Kw)		Speed (rpm)		Weight * (Kg)	Dimensions *ØxH mm
				50 Hz	60 Hz	50 Hz	60 Hz	50 Hz	60 Hz	50 Hz	60 Hz		
FTI-2M-0550	2 motors	1	550	400	460	0,42	0,4	0,2	0,22	1500	1800	98	600 x 1000 x 615
FTI-2M-0800	2 motors	1	800	400	460	0,42	0,4	0,2	0,22	1500	1800	150	800 x 1240 x 675
FTI-2M-1200	2 motors	1	1200	400	460	0,63	0,66	0,36	0,4	1500	1800	210	1200 x 1705 x 815

* Size and weight for standard configuration: 1 level + cover

HELIOS

Examples of application:

Chemical, agricultural, food, pharmaceutical products, paints, resins, waste water, plastic, glass, etc.



ADVANTAGES:

- Extremely robust and reliable. It can work 24 hours a day.
- It occupies little space.
- It allows for a large product volume.
- Central loading and unloading of material.
- Low maintenance.

Circular Sieve Shaker

FTI-0300 / FTI-0400

The VULCANO Industrial Sieve shaker is ideal for small production runs of between 5 and 75 kg, depending on the type of product.

Manufactured from AISI 304 stainless steel (or AISI 316 on request), it features an imbalanced-weight motor which produces a three-dimensional motion which makes the sieving of the product very effective. Adjustment of the imbalanced-weights allows the regulation of product behaviour on the mesh and the sieving speed.

The bottom has a side outlet through which the obtained product can be unloaded. The sieves can be ordered with or without product outlet. In the case of choosing a sieve with outlet, the sieving process can be automated: as the product enters the sieve shaker it also leaves via the sieve opening.

This sieve shaker allows up to 5 sieves of 300 or 400 mm Ø. The standard fixation system is made up of threaded steel bars, bakelite knobs and an open (for continuous feed) or closed methacrylate lid. Optionally it can be ordered with a rapid closing system, metal lid and wheels for easy moving.

If the sieve shaker is going to be used in areas classified as being potentially explosive environments then it is manufactured with ATEX materials, and FILTRA will supply the corresponding ATEX certificate.



MODEL	Sieve Shaker Type	Max. Number of sieves	Sieve Diameter	Tension (V)		Intensity (A)		Power (Kw)		Speed (rpm)		Weight * (Kg)	Dimensions *ØxH mm
				50 Hz	60 Hz	50 Hz	60 Hz	50 Hz	60 Hz	50 Hz	60 Hz		
FTI-0300	Circular	5	300	400	460	0,34	0,34	0,155	0,175	1500	1800	40	480 x 869
FTI-0400	Circular	5	400	400	460	0,60	0,60	0,24	0,27	1500	1800	50	580 x 900

* Size and weight for standard configuration: 1 level + cover

VULCANO

Examples of application:

Chemical, pharmaceutical and agricultural products, food stuffs, paint, sand, seeds, metals, wood, plastic, glass, etc.



ADVANTAGES:

- Sieve shaker for small production volumes (pilot plants).
- Highly versatile. Easy to operate.
- Sieves with or without product outlet (to choose).
- Can have wheels fitted
- Low maintenance.

Mobile Circular Sieve Shaker

FTIS-0450 / FTIS-0600

The CENTAURO is a compact, light, mobile sieve shaker. It is frequently used to carry out on-site checking and safety sieving (mountains, fields, factory, etc.) as it can easily be taken from place to place. It can be used both for liquids and solids.

It is used for products such as: enamels, paints, ceramic powders and sands, in addition to applications in the chemicals, food and agricultural industries, etc.

It is made from AISI 304 stainless steel (it can also be made to order from AISI 316, and with materials suitable for ATEX explosive atmospheres, bearing the corresponding certification). It permits only one sieving level. The mesh is easily interchanged and self-tensing.

It is available in 405 and 600 mm diameters.



MODEL	Sieve Shaker Type	Max. Number of sieves	Sieve Diameter	Tension (V)		Intensity (A)		Power (Kw)		Speed (rpm)		Weight * (Kg)	Dimensions *ØxH mm
				50 Hz	60 Hz	50 Hz	60 Hz	50 Hz	60 Hz	50 Hz	60 Hz		
FTIS-0450	Circular	1	450	400	460	0,34	0,34	0,155	0,175	1500	1800	26	460 x 880
FTIS-0600	Circular	1	600	400	460	0,60	0,60	0,24	0,27	1500	1800	35	645 x 1000

CENTAURO

Examples of application:

Enamels, paints, ceramic powder, sand, seeds, chemicals, agriculture products, food, etc.



ADVANTAGES:

- Mobile sieve, to work in the field.
- Highly versatile. Easy to operate.
- Interchangeable and self-tensing mesh.
- Adjustable height.
- Low maintenance.

Centrifugal Sieve Shaker

FTIC-0650 / FTIC-0800

The MINERVA centrifuge sieve shakers are used when high productivity is required, with two types of sieving being possible:

- Separation sieving of different granulometries in loose products with poor flow characteristics which are difficult to sieve due to their high content of humidity, grease or static.
- Safety sieving of the finished product in order to eliminate possible impurities.

Used in industrial sectors such as food, pharmaceuticals, chemicals etc., they are suitable for a wide range of products such as flours, sugars, ceramics, varnishes, pigments, plastics, etc. They can separate granulometries from 75 microns to 5 mm.

The product to be sieved is conveyed to the interior of the cylinder via the feed screw and is distributed over the whole sieve surface via centrifugal paddles. The velocity of the paddles creates a centrifugal force which pushes the product through the mesh. The largest particles or those with impurities are thrown out. The velocity and the paddles can be adjusted to the type of product.

They can be made to order in AISI 304 or AISI 316 stainless steel. If the centrifugal sieve shaker is going to be used in areas classified as being potentially explosive environments then it is manufactured accordingly and provided with the ATEX certificate.



MODEL	Sieve Shaker type	Sieve Diameter (mm)	Tension	Intensity (A)	Power (Kw)	Speed (rpm)	Weight (Kg)	Dimensions LxWxH mm
FTIC-0650	Centrifugal	2 x Ø 220 x 294	380/400 V 50 Hz	3,21	1,4	750	205	1875 x 500 x 840
FTIC-0800	Centrifugal	2 x Ø 310 x 370	380/400 V 50 Hz	5,83	2,2	900	245	2200 x 600 x 945

MINERVA

Examples of application:

Flour, sugar, chocolates, ceramics, paints, pigments, plastics, cement, plaster, etc.



ADVANTAGES:

- Sieve shaker for large production volume. High performance.
- Specially designed for humid, greasy or electrostatically charged products.
- Highly robust. It can work for 24 hours.
- Easy interchange of cylinder sieves.
- Fixed or portable.
- Silent.
- Easy to clean. Low maintenance.

Industrial V-Mixer

FTMV-16 / 25 / 75 / 250 / 500

The ATENEA industrial V-shaped mixer is used in order to achieve perfect homogenization of solid with solid (in any proportion) and solid with liquid (10% maximum) products in powder or granulated form.

It has a V-shaped body with two loading inlets and one outlet, with a butterfly valve to facilitate the unloading of the mixture. Due to the V-shape axial currents are produced when the body is turned through 360°, and these currents separate and unite the product to be mixed. This, along with the radial mixing action, produces an extremely homogeneous result (in the proportion of 1 part in 10.000).

It is possible to add an intensifying bar within the interior which breaks down lumps and reduces the mixing time. Using this intensifying bar it is possible to add liquids in spray form.

The surface finish is mirror-polished with various grades of polish as required. The mixing time varies between 3 and 15 minutes, depending on the complexity of the mixture. It is available in various models for capacities of 16, 25, 75, 250, 300 or 500 litres of product.

OPTIONAL:

- Intensifier (shaker) / humidifier bar set
- External electrical panel.
- Safety protective barriers.
- Finishes and qualities.



MODEL	Timer		Tension	Mixer Power (Kw)	Intensifying Power (Kw)	Weight (kg)	Useful Volume (l)	Dimensions L x W x H mm
FTLMV-16	Digital	0 - 90 min.	230-380 V 50 Hz	0,25	0,37	55	8	306 x 1350 x 1000
FTLMV-25	Digital	0 - 90 min.	230-380 V 50 Hz	0,37	1	80	12,5	306 x 1600 x 1000
FTLMV-75	Digital	0 - 90 min.	230-380 V 50 Hz	0,75	2,2	200	37,5	2000 x 1600 x 1800
FTLMV-250	Digital	0 - 90 min.	230-380 V 50 Hz	2,2	3	250	125	2085 x 1600 x 1850
FTLMV-500	Digital	0 - 90 min.	230-380 V 50 Hz	4,1	4,1	330	250	2500 x 1600 x 1800

ATENEA

Examples of application:

Flours and other food products in powder or grain, pigments, colourants, glass fibre, plastic in powder or granules, pesticides, herbicides, fertilizers, polymerized products, pharmaceutical products, chemical products, etc.



ADVANTAGES:

- Precision mixing. Maximum product homogenization.
- High quality materials and finishes.
- Free of interior angles or corners; there is no build up of product residue.
- Silent.
- Easy to maintain.

Accessories and spare parts

For Circular and Side Motors Sieve Shaker:

- Mesh cleaning rings (4)
- Quick clamp system (1)
- Silicone gaskets
- Springs (2)
- Sleeves: nylon, silicone (8)
- Sieve: 550, 800, 1200, 1500, 2000 mm. (5)
- Remaking sieves (5)
- Support bench
- Wheels (7)
- Control (10)
- Silicone Lids (3)

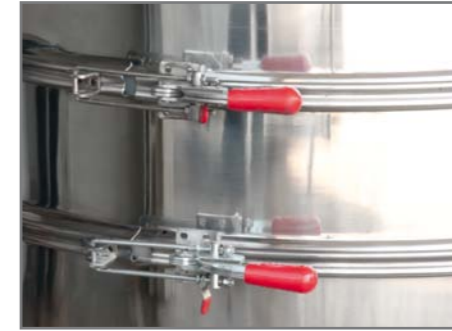

1

For Centrifugal Sieve Shaker:

- Cylindrical Sieves: St. steel or nylon (6)
- Support bench
- Control (10)



3

For "V" Mixer:

- Safety protective barriers: cage, cells, etc. (9)
- Support bench
- Control (10)
- Inox Lids (12)
- Intensifier (shaker) / humidifier bar set (11)



5



6



8



9



11

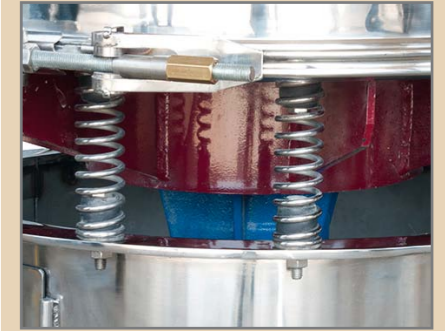

2



4



7



10



12

Distributed by:



Filtrá Vibración S.L.

FILTRA VIBRACIÓN, S.L.

Pol. Ind. Les Guixeres · C. Bronce, 1-3 · 08915 Badalona (Barcelona) · España / Spain
Tel. / Ph.: (+34) 933 956 739 · Fax: (+34) 902 190 070

filtra@filtra.com
www.filtrá.com