

MOROS

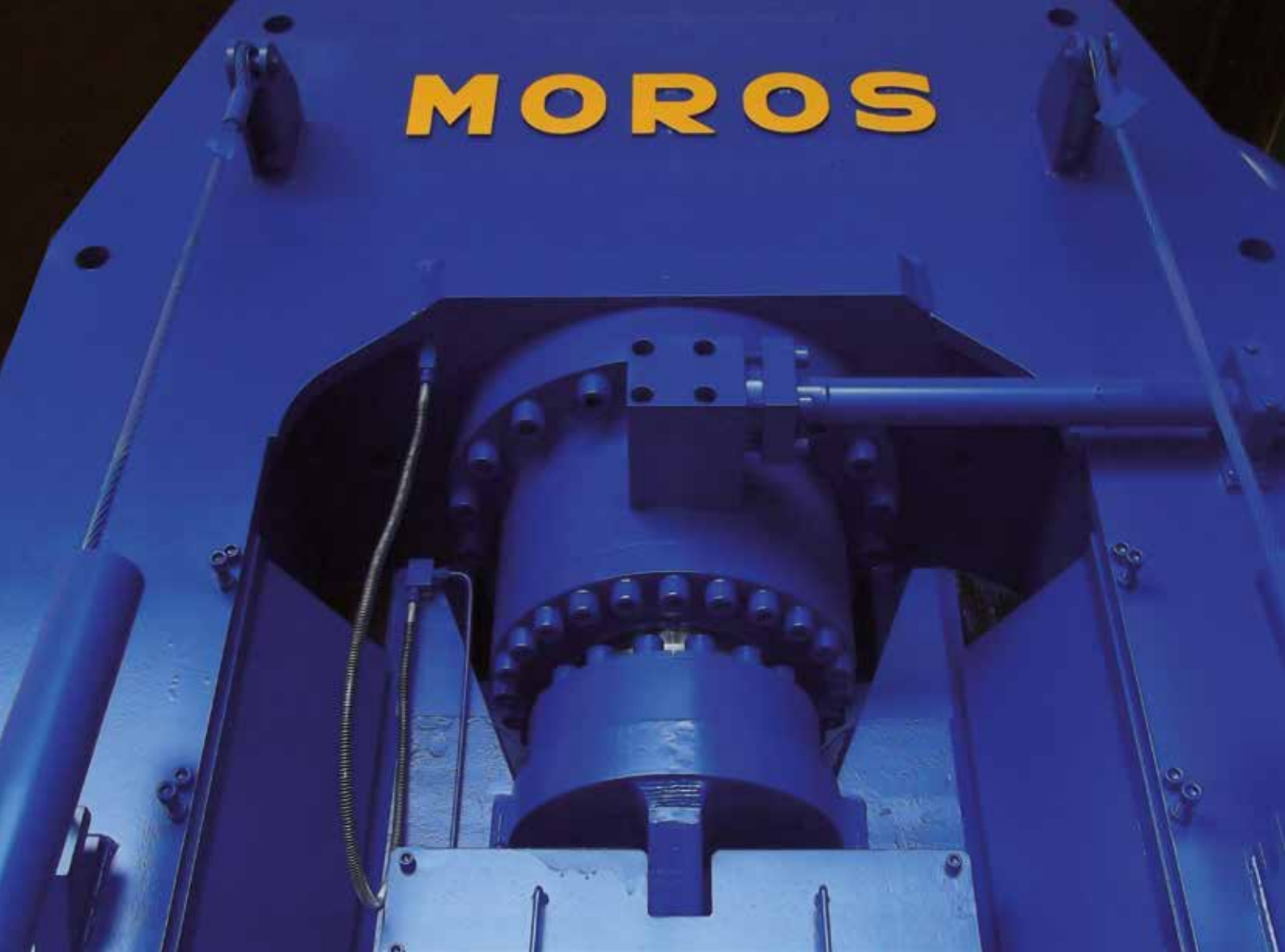

Total quality in Engineering, Design and Manufacturing is our Trademark

.....

MOROS, Industrias Hidráulicas, s.a. designs and manufactures a wide range of balers, shears and rotary shears for processing scrap and other waste. Efficient, heavy duty and reliable machines for high productivity and minimum maintenance.

Industrias Hidráulicas, s.a.



OUR COMPANY

Industrias Hidráulicas S.A. "MOROS"

Industrias Hidráulicas S.A. "MOROS" has been designing and manufacturing machinery for more than 55 years. Our range includes high quality balers, shear-balers and rotary shears for working with ferrous and non-ferrous materials, in the following categories:

- Stationary balers: one, two or three compression balers, as well as high production and density balers.
- Shear-balers with precompression wings, lateral compression shears and lateral compression shears with adjustable angle system.
- Mobile and portable balers and shears.
- Other machines such as rotary shears, alligators...
- Machinery for recycling adapted to any customer's need



MOROS has agents worldwide, providing after sales service and maintenance in many countries. You can find our contact details on our website: www.Moros.Com



Agents worldwide: Alemania • Arabia Saudí • Argentina • Benelux • Bolivia • Brasil • Bulgaria • Chile • China • Ecuador • Emiratos Árabes Unidos • Francia • Grecia • Italia • India • Paraguay • Kazajistán • Kirguistán • México • Mongolia • Uzbekistán • Rumanía • Rusia • Sudáfrica • Tadjikistán • Turkmenistán • Turquía • Ucrania • Uk & Irlanda • USA & Canadá. Ask for information in other countries.

DESIGN

Each model has been built on the basis of extensive calculations and case studies using CAD computer programs with the latest technology and computer simulation. This is complemented by our vast experience in designing, manufacturing and maintenance of machinery.

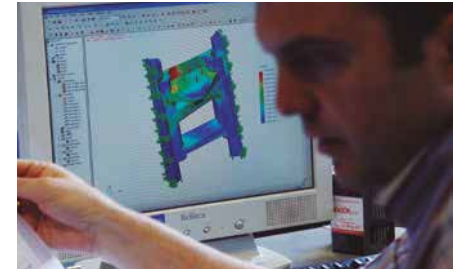

FLEXIBILITY

The constant evolution of our machinery and years of dedication to the scrap recycling market allow MOROS to satisfy any customer's need.



QUALITY

All the manufacturing methods have been developed and tested by our strict quality standard which is updated regularly. We manufacture almost all the components in our facilities.



AFTER SALES

MOROS customer service is well known worldwide, supported by the new monitoring devices via modem, avoiding unscheduled stops. Moreover, we ensure spare parts are available throughout the life of the machine and we have a large stock of other commercial components. In addition, MOROS keeps a record of all the machines manufactured in the last 55 years.



QR Code

Scan the code with your phone to see the **MOROS** corporate video.



Performance, Reliability and Productivity

SCRAP SHEAR H-P

The precompression lateral block with angle adjustable system is extremely effective for precompression of heavy bulky scrap that no other shear on the market can process.

All these advantages result in an increase of production rates. The latest trends in hydraulics and electronics allow the efficient use of power resources, making the H-P range in a very profitable machine per scrap ton produced.



Reinforced structure

After years of production, the H-P is now established in the market, thanks to its numerous technical advantages, as the best example of structural construction that characterizes MOROS.

It includes interchangeable high-strength steel wear plates in all areas in contact with the scrap.

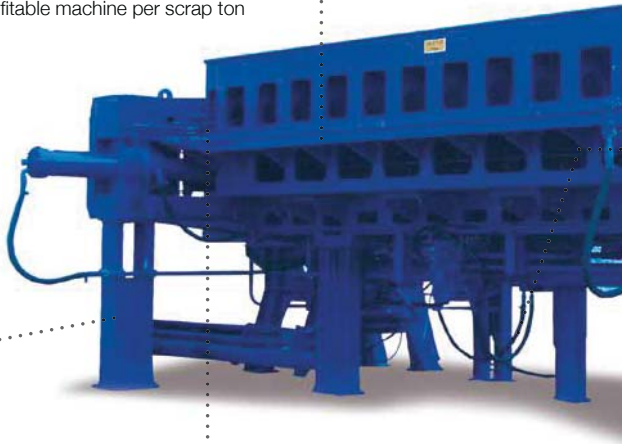

Loading boxes up to 10 metres long (box is 11.5 metres).



Technical innovations

The exclusive MOROS system stops scrap jamming at the side of the box when the angle adjustable block is turned. It avoids the scrap to jam the precompression process. This reduces unscheduled stops and allows the block to be set to maximum.

This model also includes state of the art filtering technologies, positioning cylinder control, double hydraulic circuits and system control technologies.



Head

The closed casting guillotine reinforces its structure. Extended V-shaped prismatic guide ways, adjustable and automatically greased to reduce wearing and increase cutting accuracy.

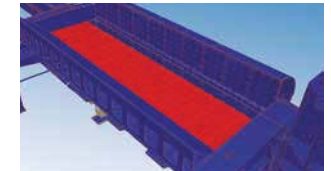
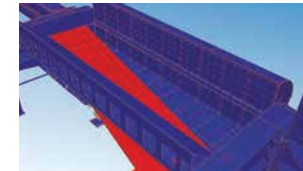

This model lets you work in parallel or angular mode. With the powerful side compression block in the parallel position and the compression lid half closed, the scrap in the box is compressed as far as possible. By selecting the angle adjustable mode the full compression force is exerted at one end of the piece of scrap providing immense crushing power.

By changing the angled force to the opposite end of the piece will practically eliminate any resistance thereby fully compressing the material

The lid is then closed, compressing the scrap downward beyond the final closed position of the lid. The side compression block is fully extended and the lid is finally closed. The log is now ready to be fed to the shear head.

TECHNICAL FEATURES

TECHNICAL FEATURES

H-P

CUTTING FORCES (Tons.) 900 - 1100 - 1400 - 1750

LOADING BOXES (meters) 6 - 8 - 10

BLADE WIDTHS (mm) 800 - 1000 - 1500

ENGINE POWER 2 to 8 units 125 hp.

AVAILABLE OPTIONS

Precompression lid length increased including loading Hopper, conveyor belt, antivibratory systems... MOROS can satisfy any requirement.



Maximum Efficacy and Versatility

SCRAP SHEAR H-B

MOROS H-B range is the latest development in the MOROS lateral precompression shear range. This high production range is known as a reliable and productive machine and many units have been manufactured worldwide.

MOROS H-B range includes many new advantages in design, hydraulics and electronics, making it a very effective and productive machine with low maintenance costs.



Productivity

High speed due to its innovative hydraulics including simultaneous movements in all the cylinders thanks to the continuous position detectors inside the cylinders. Compact hydraulic group with submerged pumps.



Every part of the machine in contact with the scrap includes interchangeable wear plates

Every part in contact with another is machined to ensure a perfect fit.

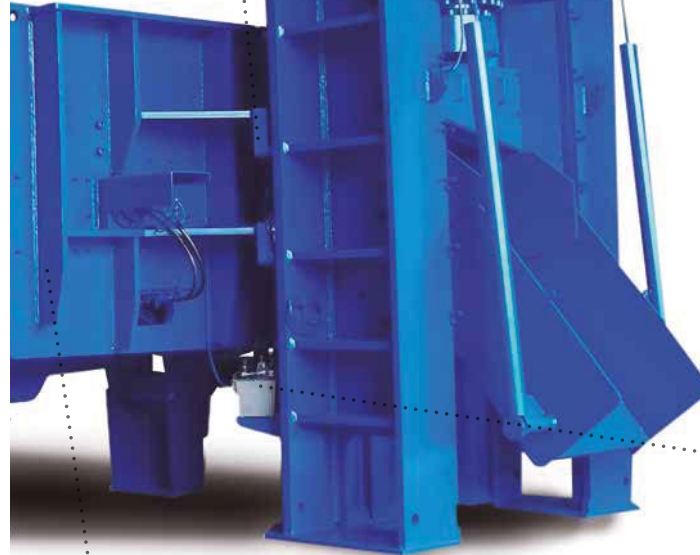
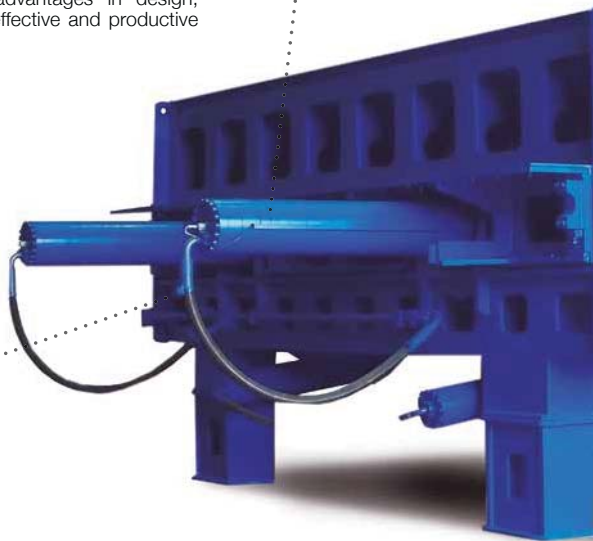

ALL THE CYLINDERS CAN BE DISMANTLED FOR EASY MAINTENANCE.

The closed guillotine structure increases head strength and permits a tray in the scrap outlet.



It includes a Hydraulic system to tighten the blades

Very useful for quick blade replacement.



Brand new design to reduce overall height for easy scrap loading

Automatic greasing in head and hinges. Also included in the precompression box.

Models with a large loading and precompression box include as standard feature a torsional cylinder to reduce the wear of the lateral block wear plates.

Different options:

Container to protect the hydraulic and electric group, extended length of the precompression lid including loading hopper, conveyor belt in the scrap outlet, antivibratory system, comprehensive enclosure.... to satisfy any customer requirement.

TECHNICAL FEATURES

TECHNICAL FEATURES

H-B

CUTTING FORCES (Tons.)

700 - 900 - 1100 - 1400

LOADING BOXES (meters)

6 - 8 - 10

BLADE WIDTHS (mm)

600 - 800 - 1000

ENGINE POWER

2 to 6 units 125 hp.



Versatile and Multi-purpose Machinery

SCRAP SHEAR H-A

The MOROS H-A range is the latest development in the MOROS stationary wing shear range, well known for its reinforced structure and its capability to work with almost every material. The H-A range incorporates new advantages in mechanical design, hydraulics and electronics to achieve cutting speeds and efficiency levels never seen before in this kind of machines.

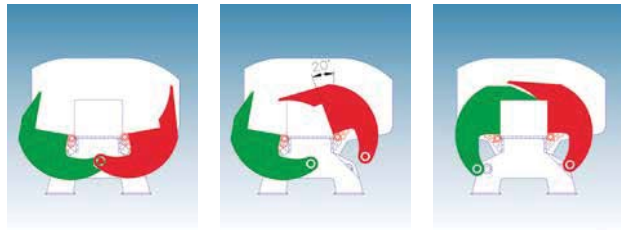

Exclusive MOROS design of the wings

The precompression box can be closed fast if you are working with light scrap thanks to the combined flat and rounded surfaces in a single wing. Unlike with a conventional wing, you can also process heavy scrap with this engineered corner in the wing. Furthermore, the overcompression mode allows scrap to be compressed in the precompression box. Larger loading box to work with car bodies and bulky scrap.

Split hinge shaft for easy maintenance and fast dismantling

Efficient and fast hydraulics
Simultaneous movements in all the cylinders. Energy saving is reached thanks to the new hydraulic technology which allows reducing the number of electric motors.



Automatic greasing in the head.
H-shaped guillotine keeps overall height low to enable loading with medium cranes from both sides and for transporting it without dismantling the head.

Grooved guiding in the hold down

Different options:

Container to protect the hydraulic and electric group, loading Hopper, conveyor belt, antivibratory system, flat foundation, cold weather construction, cabin.... to satisfy any customer's need.

TECHNICAL FEATURES

TECHNICAL FEATURES	H-A
CUTTING FORCES (Tons.)	550 - 700 - 900 - 1100
LOADING BOXES (meters)	5 - 6 - 7
BLADE WIDTH (MM)	800 - 1000
ENGINE POWER	1x150 hp; 2-3-4 x 125 hp



Special Application Shears

SCRAP SHEARS H-M, H-V, H-C, and H-G

Machinery for specific purposes that have become a standard in the MOROS range. The Moros H-M and H-V models have been designed to process long scrap like bars, pipes,...



MOROS H-M Scrap Shear

H-M shears include a fixed loading box, without wings, to allow the loading of very long objects. A pusher ram leads the material to the head, which is structured similarly to other MOROS stationary shears. As an option, it can incorporate a hydraulically operated "scrap-sizer".

The loading box could be manufactured with different lengths.

MOROS H-C shear and baler for non ferrous materials

The H-C is a machine with asymmetrical wings, designed to work with light scrap and non-ferrous metals. Thanks to its wing shape it closes very fast, allowing it to be used either as a shear or as a baler that produces a bale size of 400 x 400 mm.



MOROS H-V inclined shear
Has been designed to work with very long objects and to be very compact. It is a continuous feeding and cutting machine and thanks to the options available, such as the diesel engine or the hydraulic outriggers, it can be fully transportable.

It incorporates a mechanical bumper and, as an option, can be fitted with a hydraulically controlled "scrap-sizer" if cutting short lengths are required.

Horizontal cutting shear with continuous feeding and cutting. H-G-700 "Piranha".

Ideal scrap shear for small yards and the most economical scrap processing. Thanks to its diesel engine and the incorporated roll-off system it can be easily transported.

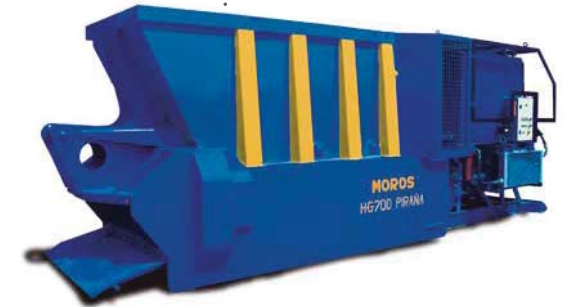

MOROS MT-Z rotary shear.

The MOROS is a ruggedly-designed, simple, electro-mechanical machine. Its low differential shaft speeds and counter-revolving shredding action are the secret to its success. MOROS literally pulls apart, tears and shears materials. "Axial play control" reduces friction on either side of the turning knives. MOROS adapts to almost every type of loading and discharge system.



TECHNICAL FEATURES	H-M	H-C	H-V	H-G	MT-Z
CUTTING FORCES (Tons.)	400 - 1100	280 - 550	400 - 630 - 900	400	-
LOADING BOXES (meters)	6 - 8 - 10	3 - 4 - 6	6 - 7	2,4	-
BLADE WIDTH (MM)	800 - 1000	400 - 600	800 - 1000	1200	-
ENGINE POWER	From 1-4 units of 125 hp.	From 1-2 units of 125 hp.	1 to 3 units of 125 hp.	Diesel 136 hp.	20 - 40-60-150 hp.



Long Life

Wide alligator shear range that has been manufactured with the standards of the bigger shears.

The gap between blades can be easily regulated for more accurate cutting and optionally they can incorporate automatic functioning.

As an option, every alligator can incorporate an automatic functioning. The clearances between blades can be adjusted for a more accurate cutting.

MACHINES TO CUT NON FERROUS MATERIAL



H-M-10/H-M-11

Fast shears (15-22 cuts/minute).
Optional automatic function available.



H-H-11

Special shear to clean non ferrous materials.



H-K-15

It is also very fast and designed to work with non ferrous or radiators (specific options available). An inclined version is also manufactured to ease the loading of bars, it incorporates a tilting hopper and an adjustable "scrap-sizer".



MACHINES TO CUT FERROUS MATERIALS



H-K-10

Shear to cut steel.



H-J-15

It can work with ferrous and non-ferrous materials thanks to its differential which can adjust the cutting speed: It has a low speed to work with steel and a faster one to work with metals so it is a very useful machine. It includes a manual hydraulic hold down and a casting head. Crushing anvil at the front (as the H-F-30 one), to reduce the volume of the material, as an option.



H-F-30

Specially designed to work with steel thanks to its reinforced structure, its automatic hydraulic hold down and its casting head. It includes a crushing anvil at the front (optional on the H-J-15 model) to reduce the volume of the material.

TECHNICAL FEATURES

TECHNICAL FEATURES	H-M-10	H-M-11	H-K-15	H-H-11	H-K-10
CUTTING FORCES (Tons.)	65	45	65	33	90
BLADE LENGTH (mm)	325	325	600	-	400
ELECTRIC POWER (Kw)	10	10	15	10	10
MILD STEEL CUTTING CAPACITIES (round /squares)	15 - 16	21 - 22	20-30	-	10-15

H-J-15	H-F-30
120	220
600	750
15	30
25 - 40	10-30



One of a Kind

GC-S RANGE

The GC-S range has no competition in the international market. These machines were designed to achieve production rates and bale densities that no other machine can match! Their technical advantages make these machines unjammable, and they can bale continuously any material and shape. These features, combined with their heavily reinforced structure and reliability make it the ideal machine for a recycling yard with heterogeneous scrap.



Steel interchangeable wear plates on all the surfaces that come in contact with scrap.

Extra thick trapezoidal grooved wear plates for long life and reduced replacement.

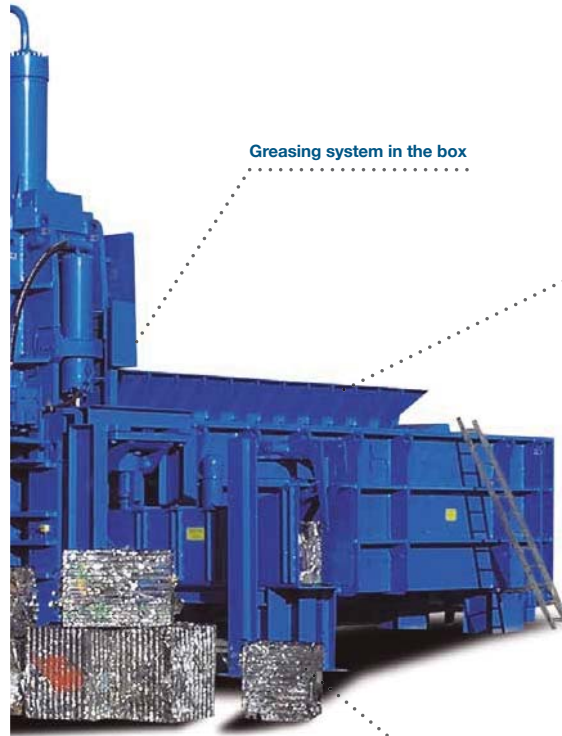

Greasing system in the box

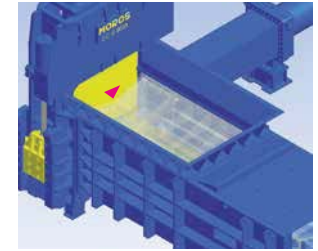

The machine has been designed to be unjammable

The cutting is done vertically with the second compression and there is no fixed bridge of blades but an actual V-shaped guillotine system. Due to the absence of the fixed bridge of blades, the loading area is bigger since it can use the last compression box. In addition, the cutting force is much higher: because it is done with the second compression instead of the first one, providing nearly twice as much cutting force.



Operating Sequence

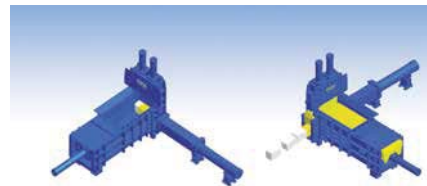

Innovative design that includes a spacer ram which lets all the cylinders move at the same time, giving very short cycle times (from 33 to 60 seconds) and high productivity (up to 60 Tn/h.) with a minimum energy consumption.

The box can be loaded during the cycle. It incorporates the latest innovations in electronics and micro filtering reducing maintenance stops.



Bale density

Bale density can be 3.5 to 4 kg/dm³.

TECHNICAL FEATURES

TECHNICAL FEATURES

GC-S

COMPRESSION FORCE (Tons.)	210 - 350 - 500 - 800
BALE SIZES (mm)	300x300 / 400x400 / 400x600 / 600x600
ENGINE POWER	2 to 75 hp. 2 - 3 - 4 to 125 hp.



Profitability in High Density

GC-V PRESS

The MOROS GC-V range was created to meet the market need for a high density range with lower production ranges than the GC-S. The GC-V also incorporates all the advantages of vertical cutting with the second compression.

Like the GC-S model, the MOROS GC-V are jam free, with a large charging box and high cutting forces for the material excess.



The machine has been designed to be unjammable

The cutting is done vertically with the second compression and there is no fixed bridge of blades but an actual V-shaped guillotine system.

Due to the absence of the fixed bridge of blades, the loading area is bigger since it can use the last compression box. In addition, the cutting force is much higher: because it is done with the second compression instead of the first one, providing nearly twice as much cutting force.

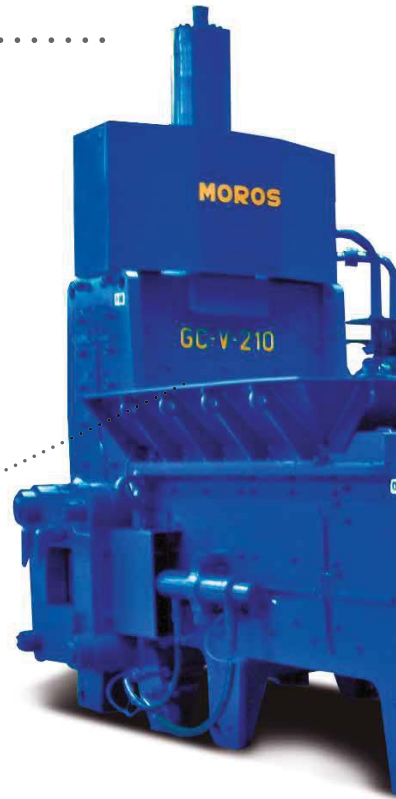

High density bales and high production rates.

It incorporates the latest innovations in electronics and filtering, reducing maintenance stops. The latest trends in hydraulics allow very short baling cycles with minimum energy consumption. Submerged pumps to reduce noise emissions.

1st compression ram with a V-shaped profile for easier cutting with the second compression.

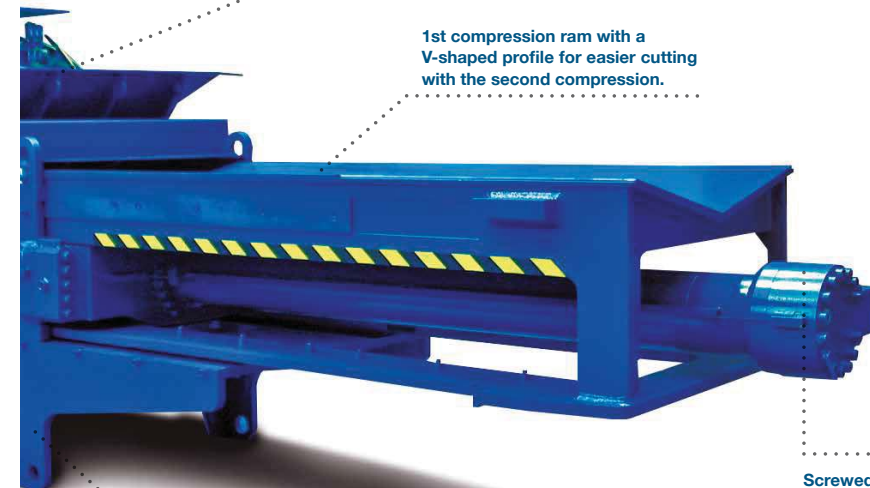

Screwed cylinders at the bottom to ease maintenance

Installation without foundation

TECHNICAL
FEATURES

TECHNICAL FEATURES

GC-V

COMPRESSION FORCE (Tons.)	210 - 280 - 310 - 550
BALE SIZES (mm)	300x300 / 400x400 / 400x600 / 600x600
ENGINE POWER	2 x 75 hp; 2 x 100 hp; 2-3 x 125 hp.



Endurance and Flexibility

GC-F AND GC-J Presses

These machines have been designed and manufactured with the most advanced technologies to withstand the demands of modern scrap processing and can work with all grades of both ferrous and non ferrous scrap. MOROS has been manufacturing the models GC-F and GC-J for decades so they are very reliable machines. Its reinforced structure allows a long lasting life with low maintenance.

All MOROS machinery is manufactured to maximum quality. All wear surfaces are protected with grooved interchangeable liner plates. The wear plates are manufactured by CNC so MOROS can provide replacement liners that match-up (including boltholes) with originals for easy replacement.

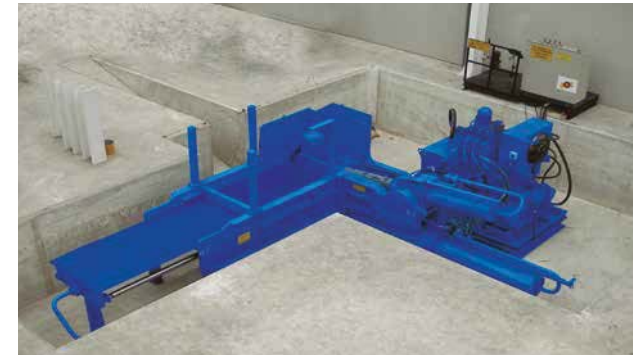
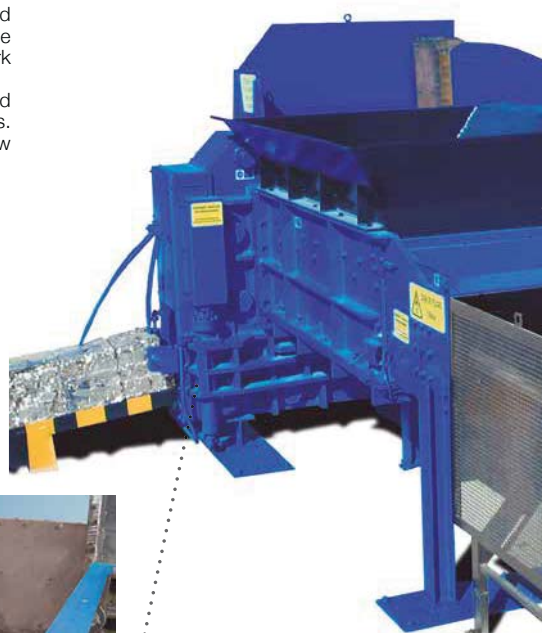

Ready to be mounted on the floor or in a pit. All the maintenance points are accessible

The wide range of available bale sizes gives enormous flexibility to satisfy any customer requirement without giving up bale density.

New hydraulic technologies and the inclusion of a differential means cylinders can be fed in quickly, giving very short cycle times and an increased productivity.



Furthermore, the precompression box can be loaded while the bale is being done so the machine can work continuously in automatic mode cutting loading time to a minimum.

TECHNICAL FEATURES

TECHNICAL FEATURES	GC-F and GC-J
COMPRESSION FORCE (Tons.)	150
BALE SIZES (mm)	300x300 / 400x300 / 500x200 / 400x400
ENGINE POWER (hp.)	60 - 75 - 125

Special Application Presses

MOROS GC-L WING BALER WITH OPPOSITE CYLINDERS

The GC-L baler is a stationary and electric model that incorporates two opposite final compression cylinders.

GC-L-D

This model includes opposite wings (with 3 strong cylinders each one) and a loading box length of 6,000 mm. that have been developed to work with big cars and vans.



GC-L-B

Very fast baler for cars.



MOROS GC-G-200

TRIPLE-ACTING SHEAR-BALER PRESS

It is a three compression baler designed to cut and bale tubes and long objects by including an inclined hopper with a hold down. The first compression lid closes (once or several times) cutting the material before baling it.



MOROS GC-K BALER RANGE

This two-compression baler incorporates a large hopper for loading, cutting and pressing bulky scrap or even car bodies, making it a very versatile machine.



TECHNICAL FEATURES

TECHNICAL FEATURES	GC-L-B	GC-L-D	GC-G	GC-K
FINAL COMPRESSING FORCE (Tons.)	125 each	165 each	220	110 - 165 - 220
BALE SIZES (mm.)	1,000 X 600	1,000 X 600	500 x 400	400 x 400 / 500 x 600
ELECTRIC POWER (h.p)	150	150	100	60 - 100 - 150



GB-C and GC-E Presses



GB-C-15 mode

Manual functioning with levers and grooved wear plate in the floor of the precompression box. The width of the precompression box eases the loading of the material and the transport of the bales.

Like the larger machines in the range, MOROS has designed and manufactured these models including wear plates which are easily interchangeable and optionally grooved if they are going to work with low thickness materials. We offer several bale sizes and manual or automatic versions for processing ferrous or non-ferrous materials.

GB-C-15-S mode

Automatic version with an extended length of the loading box and higher compressing forces.

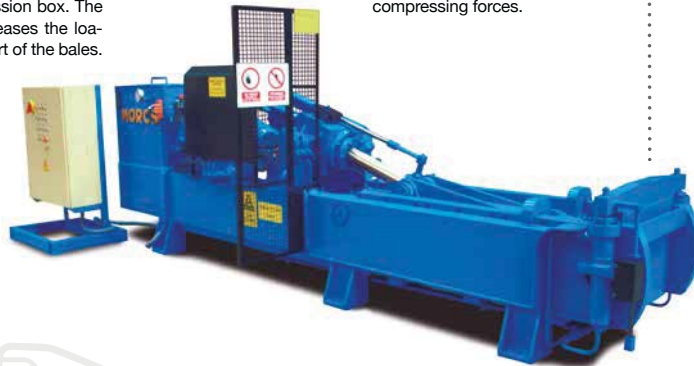

GB-C-25 model

More powerful version ideal for working with ferrous materials thanks to its reinforced structure and its cylinder forces.

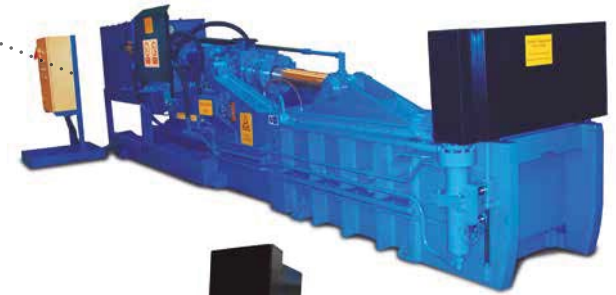

GC-E-25 model

It can work with ferrous materials due to high cylinder forces and bigger bale sizes to improve the production rates with these materials.

GC-E-30 model

It has been specifically designed to work with ferrous materials thanks to big bale sizes, its reinforced structure and its strong cylinders with high cutting forces.

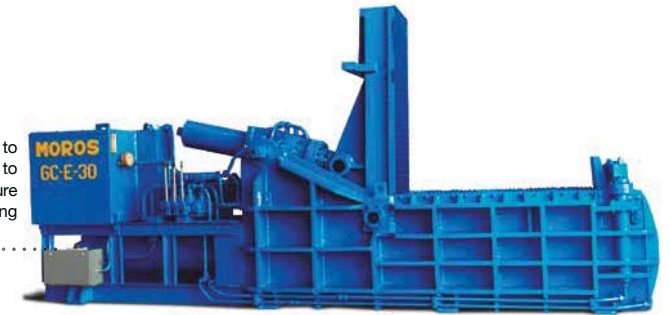

GC-T-30

This one compression continuous loading baler includes a loading hopper. It has been designed to bale cans or other light materials.



TECHNICAL FEATURES

TECHNICAL FEATURES	GB-C-15	GB-C-15-S	GB-C-25	GC-E-25	GC-T-30
COMPRESSION FORCE (Tons.)	60	80	100	100	30
BALE SIZES (mm)	500 x 200	500 x 200	500 x 200	400 x 400 - 500 x 400 - 600 x 500	300 x 300
ENGINE POWER (hp.)	15	15	25	25	15
LOADING BOXES (mm)	1000 x 500 x 450	1000 x 500 x 450	1500 x 500 x 500	1200 x 400 x 600/1200 x 500 x 600/1500 x 600 x 700	1300 x 300 x 300

GC-E-30

125
600 x 400
30
1500 x 600 x 600



Portability and Toughness

H-A-B SCRAP SHEAR

Head structure developed from the stationary version, called H-A. MOROS has developed a portable machine with the structural design and features of the stationary range H-A.

Moreover, the portable H-A-B model inherits all the state of the art hydraulics and electronics that have made the MOROS H-A range a benchmark in the market for its reliability and efficiency.

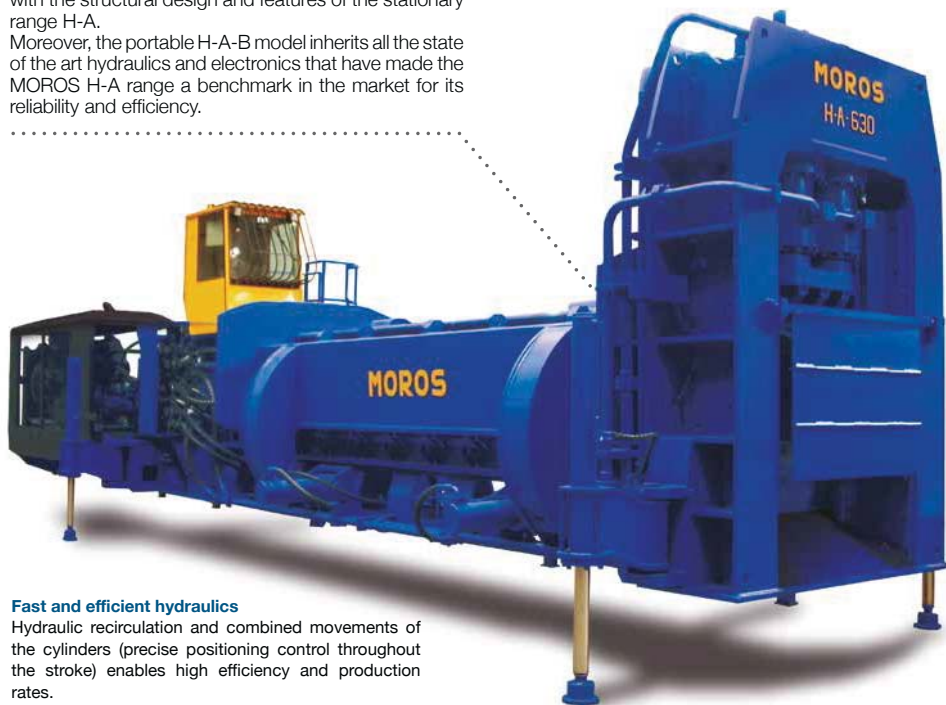

Fast and efficient hydraulics

Hydraulic recirculation and combined movements of the cylinders (precise positioning control throughout the stroke) enables high efficiency and production rates.

The exclusive MOROS design of the wings



The innovative design lets you close the machine fast if working with light scrap, thanks to the combined flat and rounded surfaces in a single wing.

Unlike with a conventional wing, you can process heavy scrap with this engineered corner in the wing.

Furthermore, the overcompression mode lets you compress the scrap in the precompression box.

H-S SCRAP SHEAR

The main feature of the MOROS mobile range is that the machine is self-supporting: the structure is also the chassis so a trailer is not needed and the total weight of the machine is used in the reinforced structure. The mobile MOROS shear is perfect for frequent travel, and it is a benchmark design thanks to its structure.



The guillotine can be adjusted for maximum accuracy on the blades and it includes automatic greasing in the head.

Fast and efficient hydraulics

State of the art technology for optimal efficiency and productivity.

ABS system, pneumatic suspension, ... also available.

TECHNICAL FEATURES

TECHNICAL FEATURES	H-A-B	H-S movil
CUTTING FORCES (Tons.)	550 - 630 - 900	550 - 630
LOADING BOXES (m)	5 - 5,5 - 6	5 - 5,5 - 6
ENGINE POWER (hp.)	300 - 400 - 530	300 - 400 - 530

Electric versions also available

Industrias Hidráulicas, s.a.



Fully Autonomous

MOROS GC-L MOBILE SCRAP LOGGER-BALER

MOROS GC-L mobile balers have been designed with two opposite compression cylinders. It includes a trailer, diesel engine and a crane so it is a fully mobile and autonomous machine.

The crane has a soft stop function and allows simultaneous movements to reduce loading and unloading times.

The crane and the baler can move simultaneously and when the crane stops, all the hydraulic function diverts to the machine for faster cycle times.



Continuous oil filtering system.



Optionally, the exclusive MOROS wing shape of the stationary MOROS shears could be incorporated.

An oil collection system is standard for car processing.

It bales 30/40 cars per hour on average.

Axle lengths can be modified to meet local transportation laws.

300 H.P engine.

MOROS GC-M MOBILE PRESS

The MOROS GC-M has been designed to process white goods or general scrap including an automatic expulsion door.



Loading crane and diesel engine included, optionally a trailer.



Standard diesel engine 175 H. P.

Filtration system in the crane and automatic regulation of power.

Powerful last compression cylinder of 165 Tons.

Compression system with opposite asymmetric wings
Designed to reduce cycle times with light scrap.



Reinforced wings with two cylinders each (110 and 165 tons).

TECHNICAL FEATURES

TECHNICAL FEATURES	GC-L	GC-M
BALING FORCES (Tons.)	110 - 165	165
LOADING BOXES (m)	5 - 5,5 - 6	4,2 - 5
ENGINE POWER (hp.)	300	175
BALE SIZES (mm.)	1.000 x 600	600 x 500





www.moros.com



Industrias Hidráulicas, s.a.

P. I. Malpica, calle E, nº 54-55 - Apartado 662 - 50016 ZARAGOZA - Spain
Tel. +34 976 57 34 10* - Fax +34 976 57 23 54 - morosihsa@moros.com